

DINO 4X200W SOLAR LIGHT TOWER



The SUPER EMPOWER® Solar Light Towers provide bright, energy-efficient lighting solutions. Powered by free renewable energy from the sun, in conjunction with heavy-duty LED light fixtures, it can be used in moderate to heavy lighting applications where a diesel, gas, or electric generator-powered light tower is needed.



"WE EMPOWER WATT MATTERS"

OUR
BRANDS



hello@super-empower.com



(510)891-1056



super-empower.com

Copyright©2018-2025 SOLTECH LLC,
All Rights Reserved.



DINO Solar Light Tower

4X200W

CATALOG		COMMENTS
PROJECT		
PREPARED BY		
DATE		

ABOUT OUR TOWERS

The SUPER EMPOWER™ Solar Light Tower features a compact trailer, fixed-brightness LED lights, and 21 ft masts.

- Four heavy-duty LED light fixtures can be programmed for desired brightness from 25% to 100%. The lights can be individually aimed without the use of tools, and they stay where you point them. Select from 100W to 200W settings and up to 160,000 lumens.
- To Maximize battery life, the control is equipped with several selections, including automatic ON/OFF from dusk to dawn and selectable run times from 1 to 12 hours. The system's smart MPPT controller provides up to 30% more charging capacity, maximizing every available amp for optimal charging efficiency.
- The 'Electric Mast Operating Safety System' provides not only safety but also reduces operational requirements.
- With the electric rotating solar panel, the whole system features outstanding power efficiency for reliable performance and long runtime.
- Easy-to-read meters give local access to view all the power performance information.





DINO Solar Light Tower

4X200W

FEATURES

- S Zero Emission with no fuel and electricity bills**
- S Low maintenance with no engine or alternator**
- S Dusk to Dawn functions via photocell**
- S Adjustable-tilt solar array**
- S Automatic and manual operating modes including Power saving modes**
- S Rechargeable with standard 120V charging**
- S Dimmable LED lights can be individually aimed at different angles**
- S Electric Mast Operating Safety System**
- S Sealed, maintenance-free batteries**
- S 200Lumen/W, up to 160,000 lumens**



Access our website by scanning our QR code

CATALOG		COMMENTS
PROJECT		
PREPARED BY		
DATE		

APPLICATIONS

- CONSTRUCTIONS:**
Our silent, zero-emission, off-grid portable solar light tower is revolutionizing the construction industry. It illuminates your workplace and provides security with no fuel.
- DISASTER RELIEF:**
Whenever disasters occur, the ability to quickly source emergency light is critical to save lives and minimize damage.
- TRAFFIC:**
These high-intensity, vehicle-mounted telescoping light towers provide the illumination needed to complete nighttime rescue, disaster, or investigative operations safely.
- MINING:**
Light towers are a vital 'backbone' piece of equipment in mining scenarios.
- FILM + TELEVISION:**
Portable & Mobile Solar Light Tower delivers zero-emission lighting with quiet operation perfect for film and television locations.
- EVENTS:**
It has never been easier to stage an event than with the help of light towers to provide security and illumination.
- UTILITIES:**
Utility organizations can use Solar Light Towers for multiple purposes with no fuel.



DINO Solar Light Tower

4X200W

CONTROL PANELS

- Programmable Solar Light Towers
- Exceptional Programmability
- Automatic and Manual operation modes
- Simple on/off controls

LOCAL MONITORING AND CONTROL

01. Simple ON/OFF Controls



02. Panel Agnel

Adjustments of the solar panel angle via the "panel angle" switch.



03. Mast

This is an Electric Mast Operating Safety System. The height of the mast can be adjusted by pushing the "MAST" button.



04. Power Monitor

Easy-to-read meters give local access to view all the power performance information.



CATALOG		COMMENTS
PROJECT		
PREPARED BY		
DATE		

SUPER EMPOWER™ Solar Light Tower offers a number of choices for power system monitoring and management.

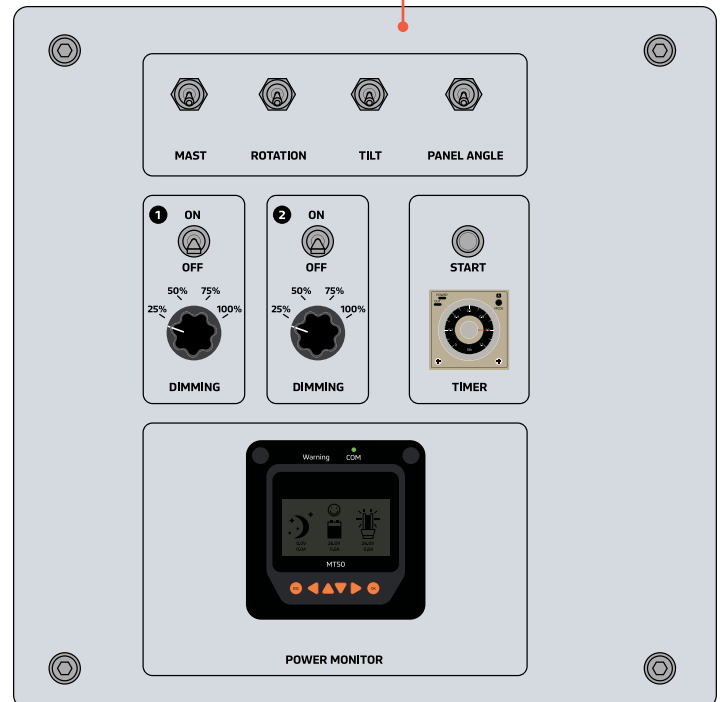

DINO Solar Light Tower

4X200W

CATALOG		COMMENTS
PROJECT		
PREPARED BY		
DATE		

05. Brightness levels

from 25% to 100%
Lights are dimmable with different brightness at 25%, 50%, 75% and 100%

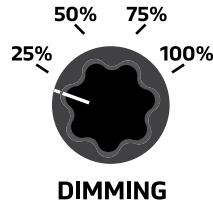

DIMMING

08. Tilt

The LED lights can be tilted at 90 degrees.



TILT

06. Timer Control

Module

The control is equipped with automatic ON/OFF from dusk to dawn and stable run times from 1 to 12 hours.

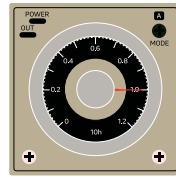

TIMER

09. Rotation

The LED lights can be adjusted at 360 degrees.



ROTATION

07. Select Lights to Control

Synchronize control two lights. The left switch controls the left two lights, and the right one controls the right two lights.

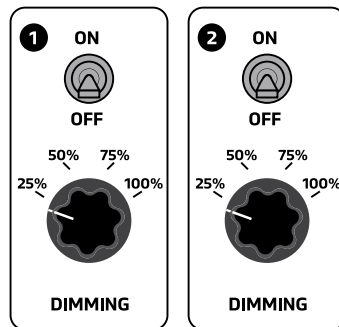

Access our website by scanning our QR code



DINO Solar Light Tower

4X200W

SPECIFICATIONS

GENERAL

MODEL	DINO 4 X 200W
COVERAGE AREA	35,000 ft ²
LIGHT	4 X 200W adjustable LED light fixtures
LUMINOUS FLUX	40,000 lumens per fixture, 160,000 total lumens
BATTERY CAPACITY	8 X 200Ah, DC12V, 19,200Wh
BRIGHTNESS (25%)	76 hours
BRIGHTNESS (50%)	38 hours
BRIGHTNESS (75%)	25 hours
BRIGHTNESS (100%)	19.2 hours
BATTERIES:	GEL (Charging Temp. -20°C/-4°F to 50°C/122°F)
WINCH	Electric Lifting
CHARGE TIME:	9.3 hours by Solar, 8 hours by AC
AC CHARGER	2.5kW / 2.5kVA, AC120V
DEPLOYED FOOTPRINT	137 X 64in (362 X 165cm), L X W
WEIGHT APPROX.	3086lb (1400kg)

CATALOG		COMMENTS
PROJECT		
PREPARED BY		
DATE		





DINO Solar Light Tower

4X200W

CATALOG		COMMENTS
PROJECT		
PREPARED BY		
DATE		

SOLAR PANEL

TYPE	Mono Crystal Silicon
QUANTITY	4
WATTAGE	4 X 435W, Tilt

MAST

HEIGHT	24 feet (7.3m) fully extended; lights operate at any height
SECTIONS	5

TRAILER

TIRE	2 X 15 in
TOW HITCH	2" ball
AXLE	Singe Suspension
FORKLIFT HOLE	2
OUTRIGGER	4 X Manual Galvanized

WARRANTY	1 year
----------	--------



Access our website by scanning our QR code



DINO Solar Light Tower

4X200W

SOLAR YIELD vs. ENERGY DEMAND

DINO solar light tower is equipped with an outstanding charging efficiency for reliable performance and long runtime. Batteries provide power and an automated solar-based charging system keeps the batteries charged. The system's smart MPPT controller provides 30% more charging capacity, maximizing every available amp for optimal charging efficiency.

When the solar yield is greater than the energy demand from the lights, the autonomous operation is possible. When the demand exceeds the solar yield, external charging is required.

CATALOG		COMMENTS
PROJECT		
PREPARED BY		
DATE		

In this solar light tower performance chart, the SUPER EMPOWER™ team selected nine major cities in the U.S. to show how environmental temperature and seasonal variation impact the charging performance.

The charts shown are representative of dusk-to-dawn operation, 7 days a week.

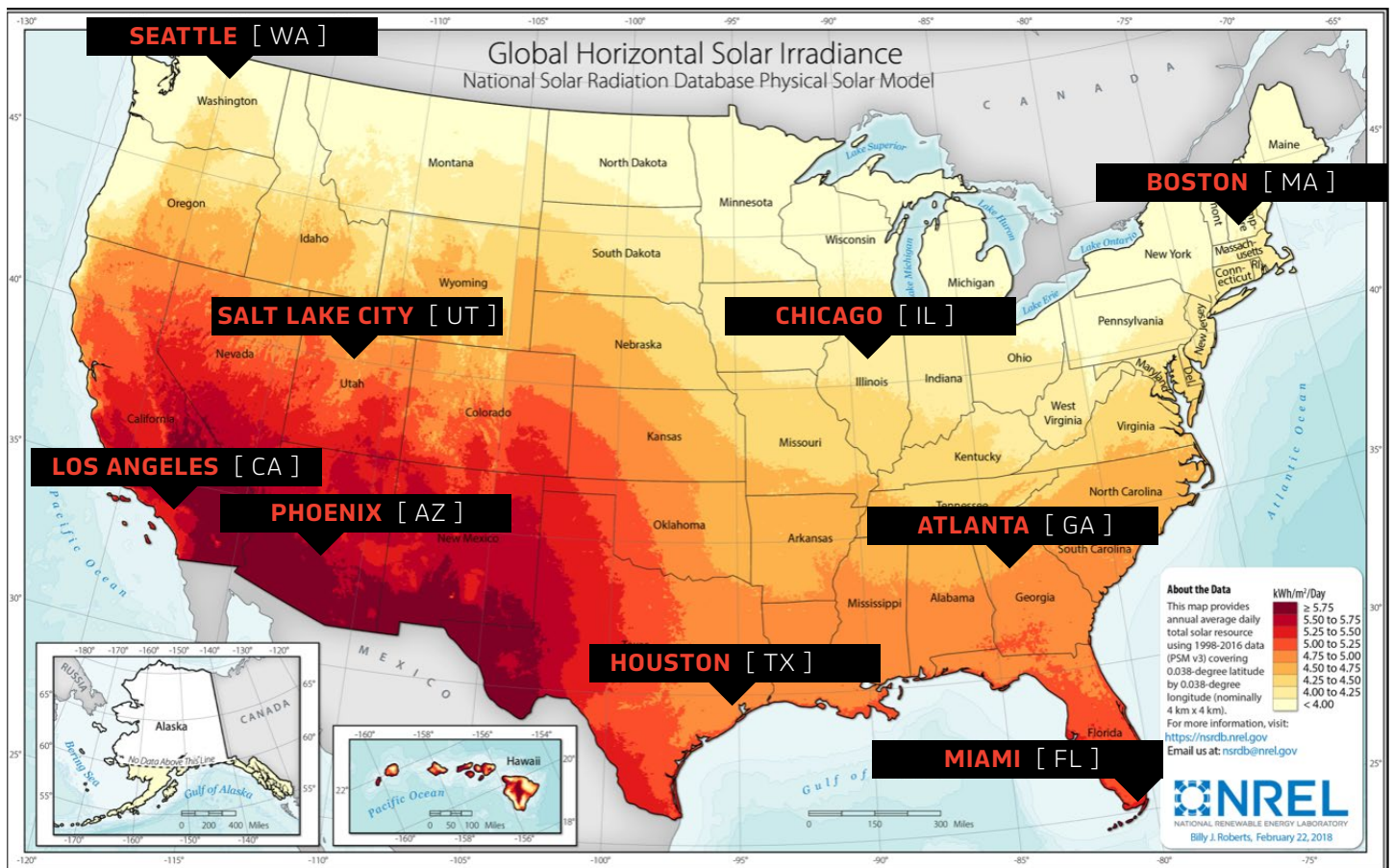

1000W/m²/day—US Photovoltaic Average Per Day

NOTE: This infographic displays solar insolation values for the capital city in each US State. The actual value for your project will vary depending on location. Sun hours are calculated assuming a south-facing panel at 45 degree tilt and winter sun hours.

Annual average solar resource data is shown for a tilt-latitude collector. The data for Hawaii and the 48 contiguous states is a 10km, satellite model dataset (SUNY/NREL, 2018). The data for Alaska is a 40km dataset produced by the Climatological Solar Radiation Model (NREL, 2018).



CATALOG	COMMENTS
PROJECT	
PREPARED BY	
DATE	

DINO Solar Light Tower

4X200W

SEATTLE

[WA]

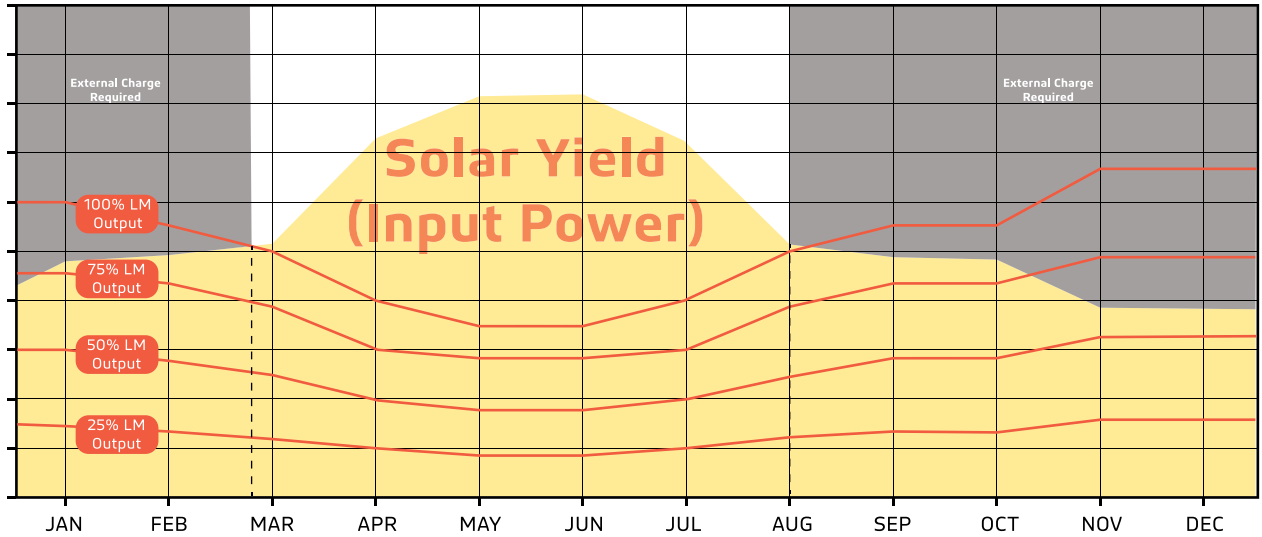

SALT LAKE

[UT]

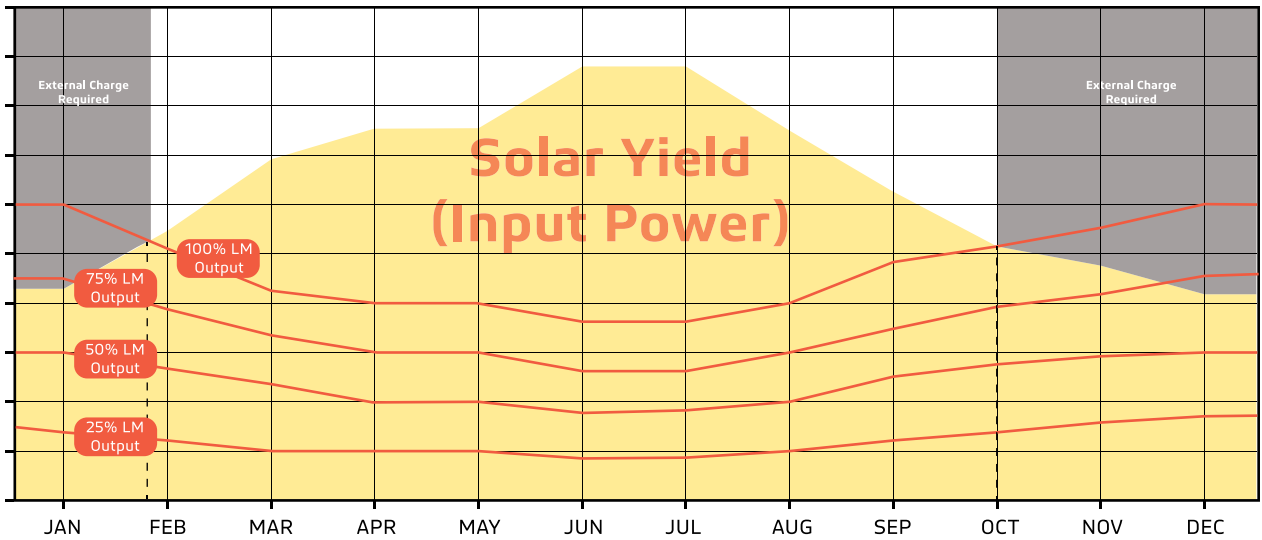

LOS ANGELES

[CA]

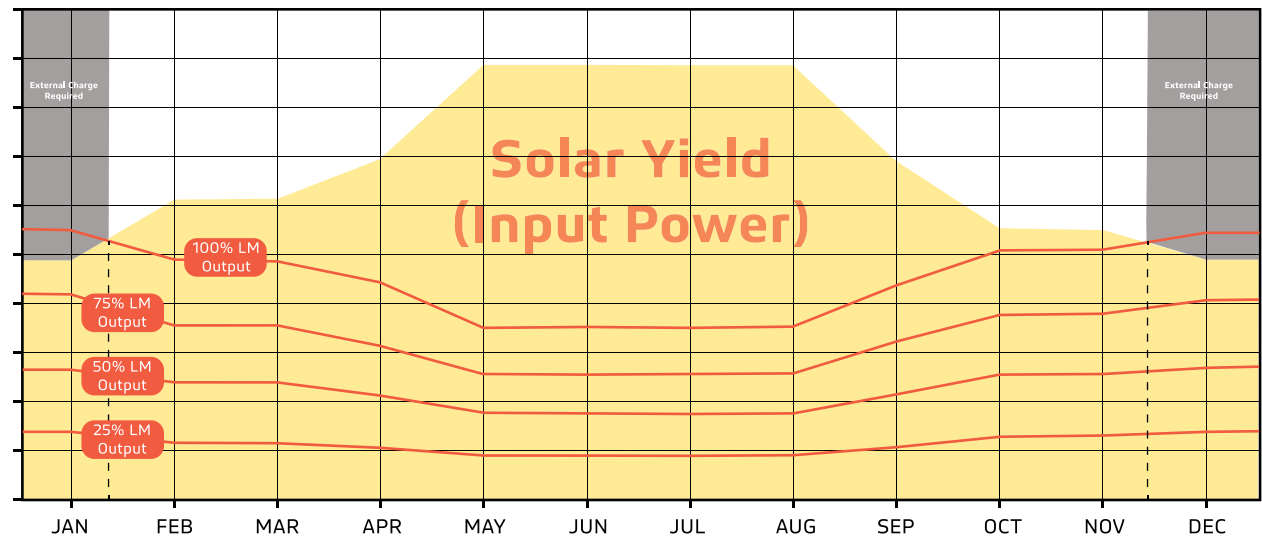



CATALOG	PROJECT	COMMENTS
PREPARED BY		
DATE		

DINO Solar Light Tower

4X200W

PHOENIX

[AZ]

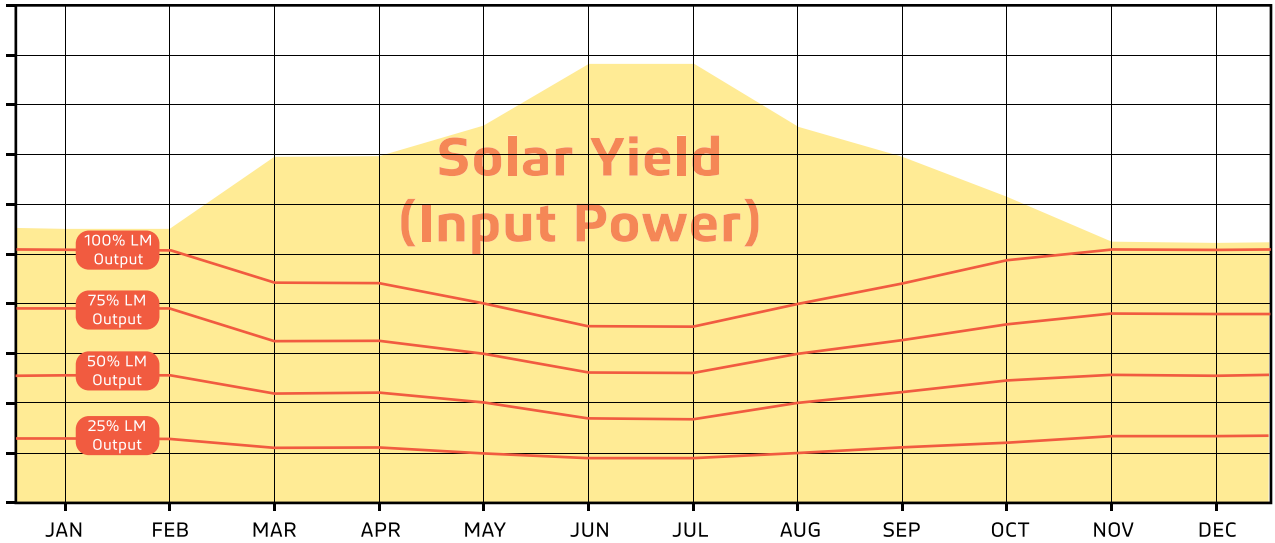

HOUSTON

[TX]

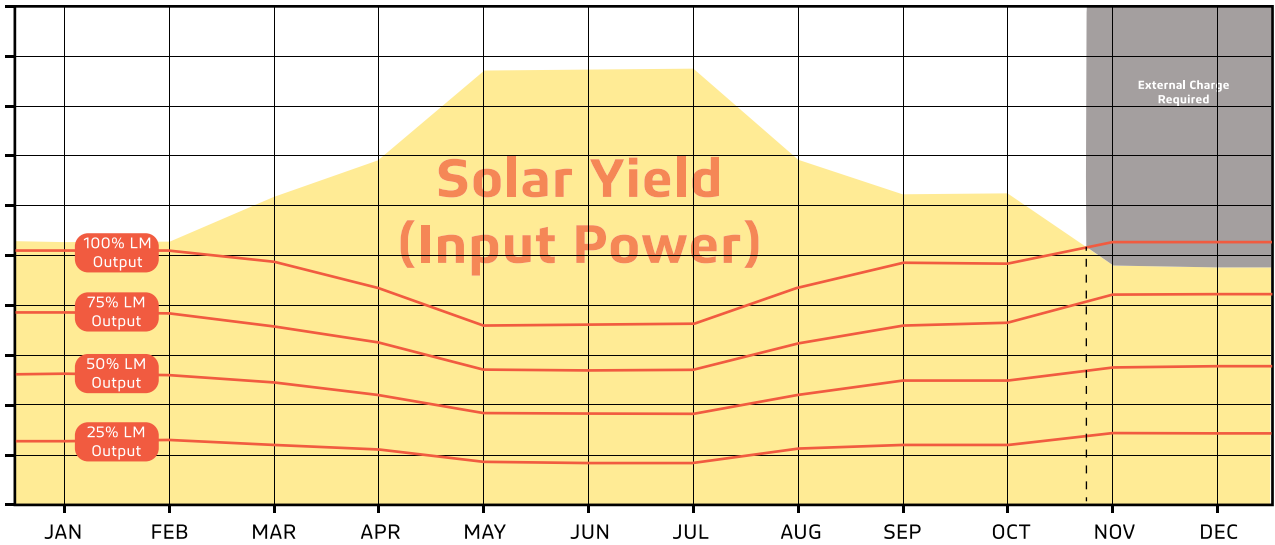

MIAMI

[FL]

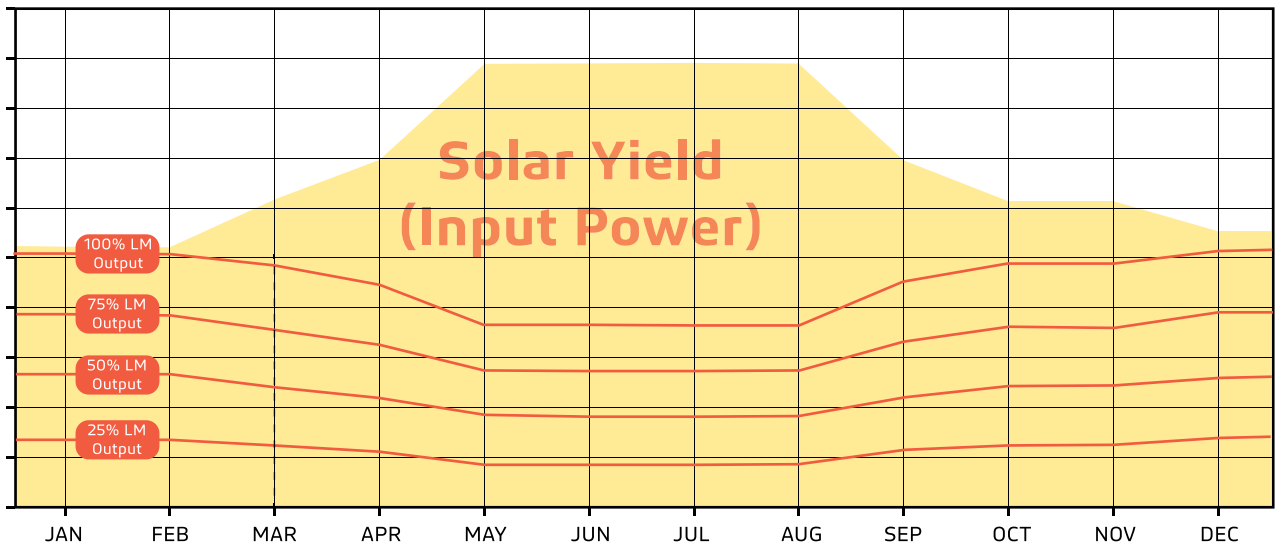



CATALOG	COMMENTS
PROJECT	
PREPARED BY	
DATE	

DINO Solar Light Tower

4X200W

BOSTON

[MA]

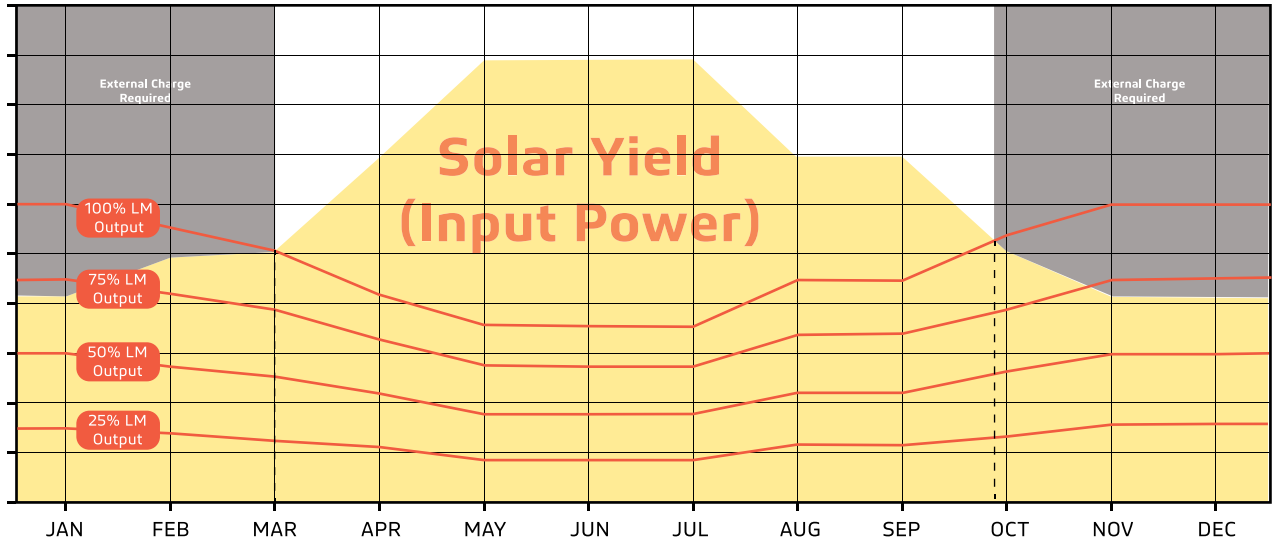

CHICAGO

[IL]

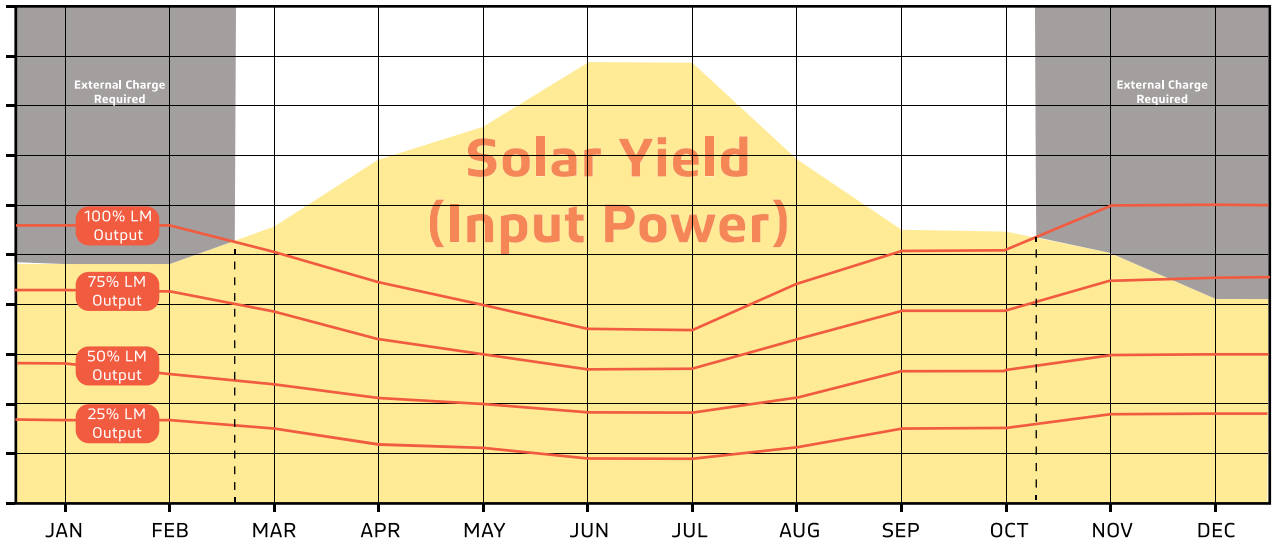

ATLANTA

[GA]

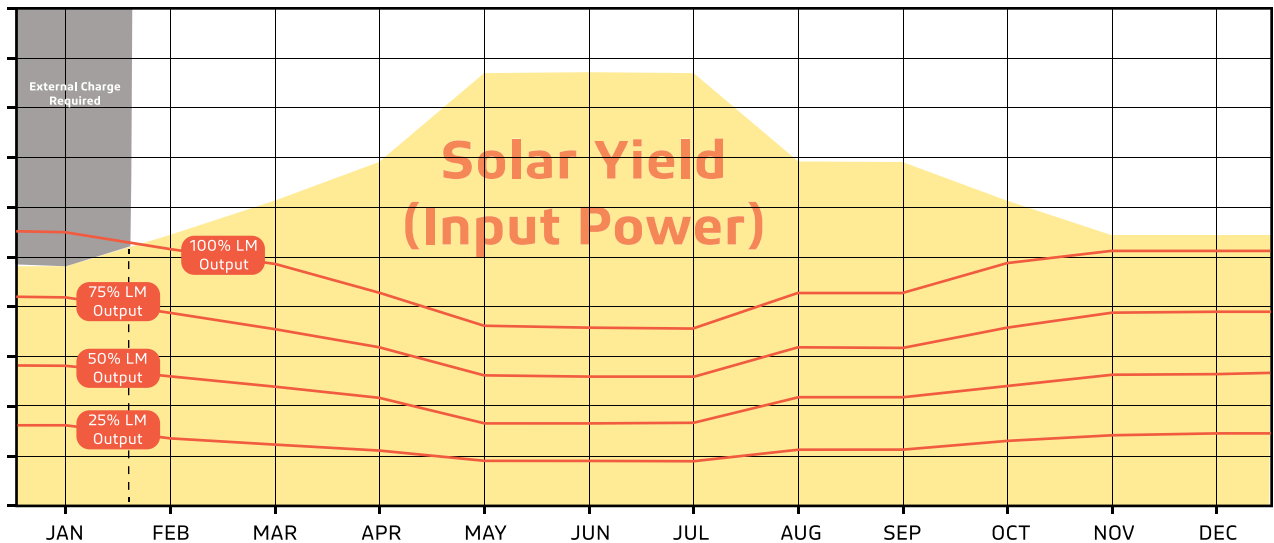



DINO Solar Light Tower

4X200W

CATALOG		COMMENTS
PROJECT		
PREPARED BY		
DATE		

LIGHT

Four Light Towers on a Regulation Soccer Field

LIGHT HEIGHT

24 ft.

LIGHTING AREA

380 X 260 ft.

TOTAL ACREAGE

2.27

ILLUMINANCE

6.12 fc Average across entire area at 100% brightness

AVERAGE ILLUMINANCE, FC

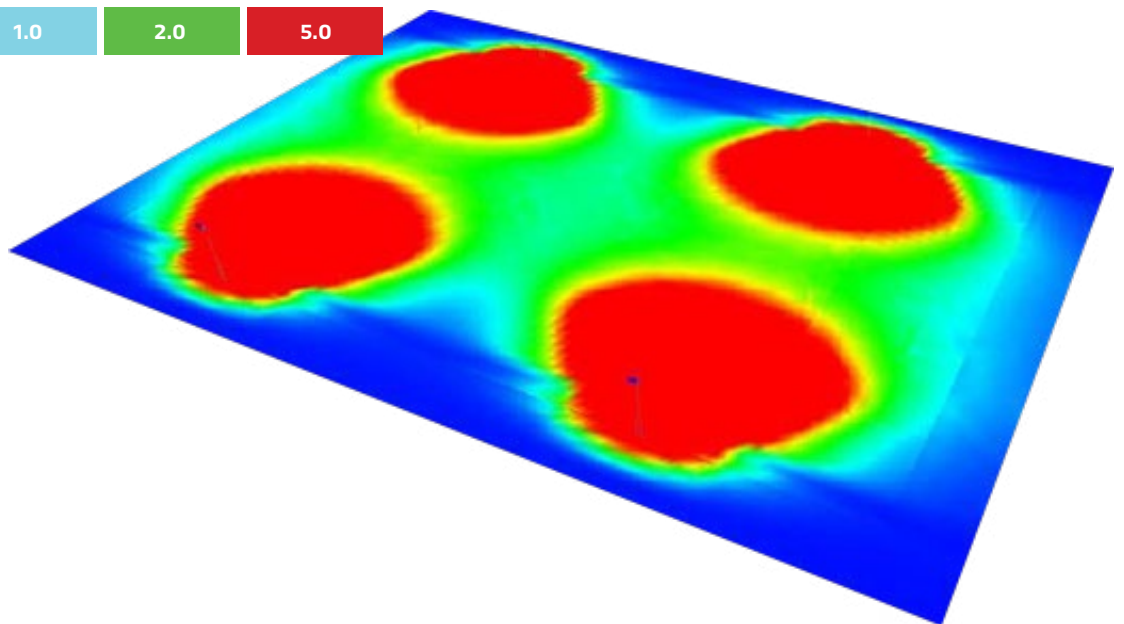
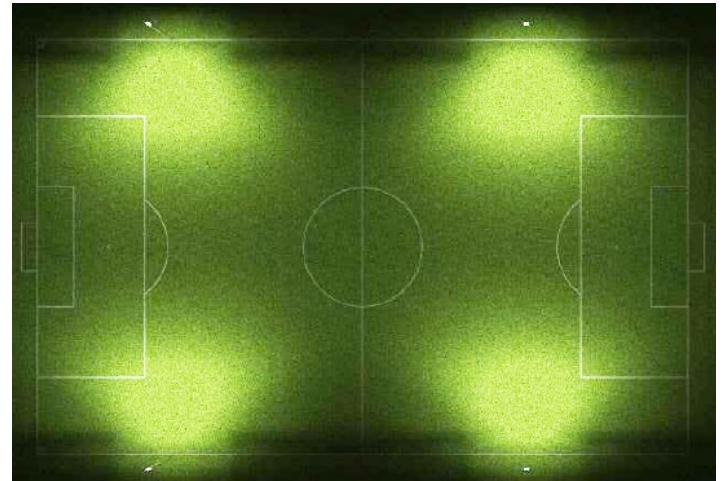
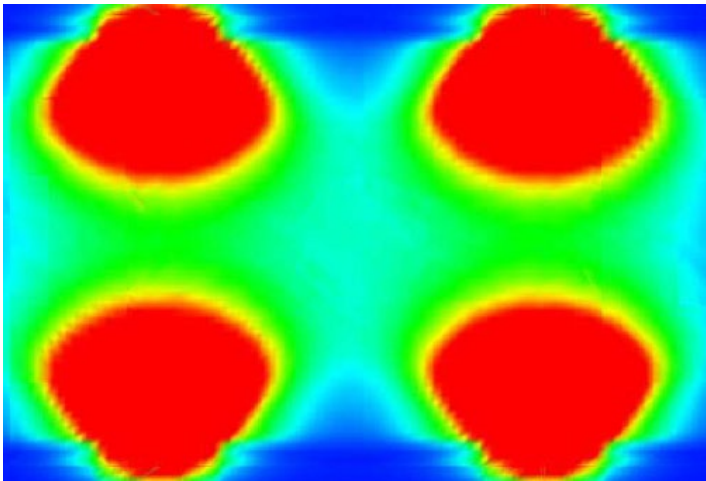

Access our website by scanning our QR code



DINO Solar Light Tower
4X200W

CATALOG		COMMENTS
PROJECT		
PREPARED BY		
DATE		

LIGHT Single Light Tower Isolines

LIGHT HEIGHT 24 ft.

LIGHTING AREA 200 X 200 ft.

TOTAL ACREAGE 0.92

ILLUMINANCE 3.54 fc Average across entire area at 100% brightness

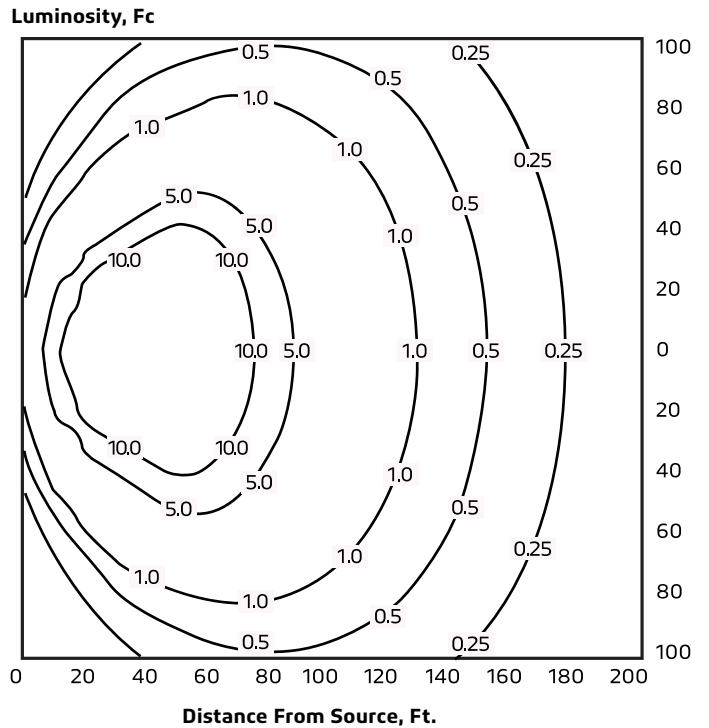
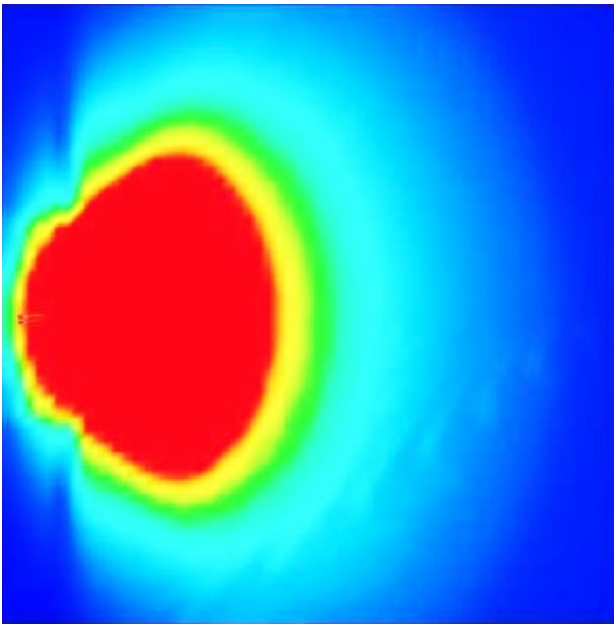

Typical recommended light levels based on Illuminating Engineering Society (IES) documents except where noted:

- General Construction:** 10 fc
- Self-parking:** 1 fc
- Active Industrial Yards:** 5 fc
- Haul Roads:** 0.5 to 1 fc
- Flagger:** 5 fc (per MUTCD)
- Quarries & Pit Mines:** 5 fc



DINO Solar Light Tower

4X200W

PRODUCT SIZE

CATALOG		COMMENTS
PROJECT		
PREPARED BY		
DATE		

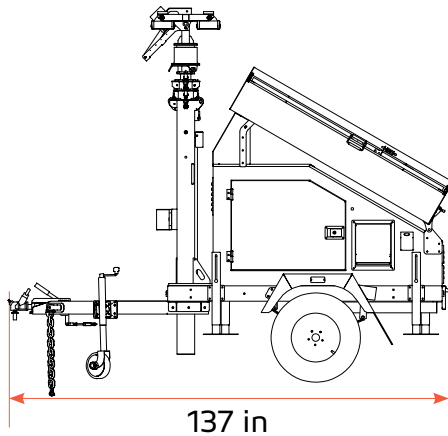
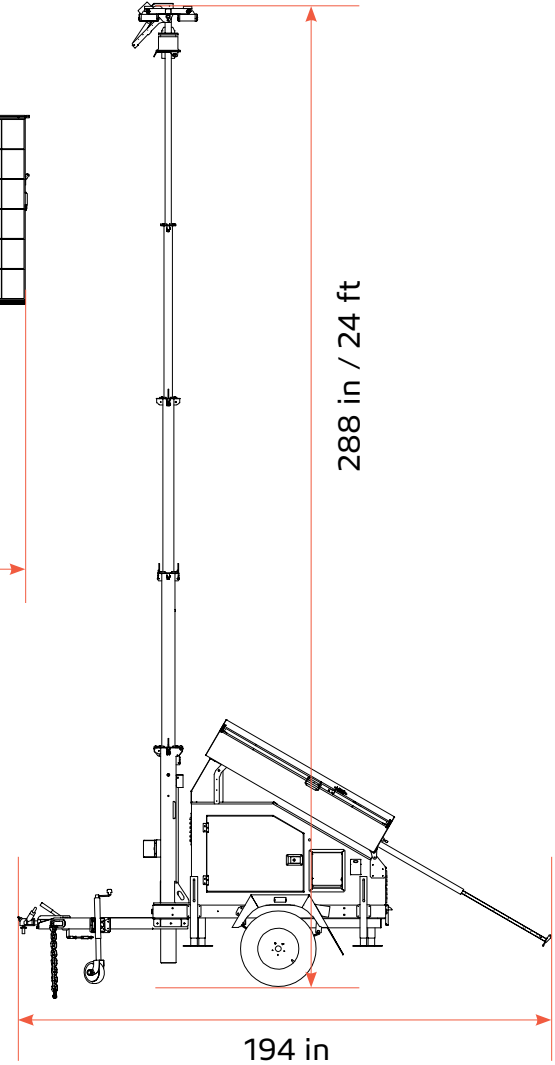
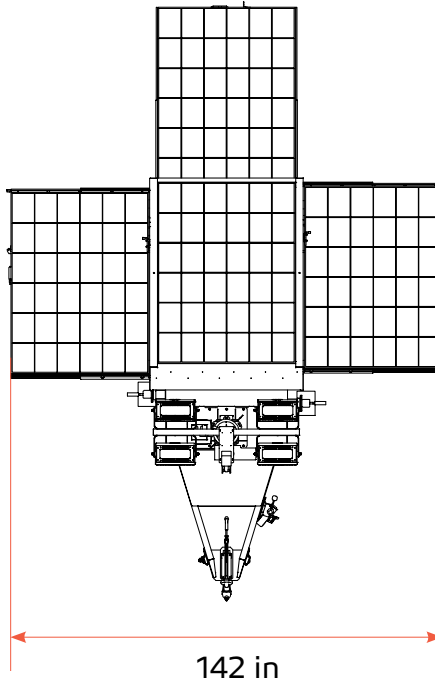
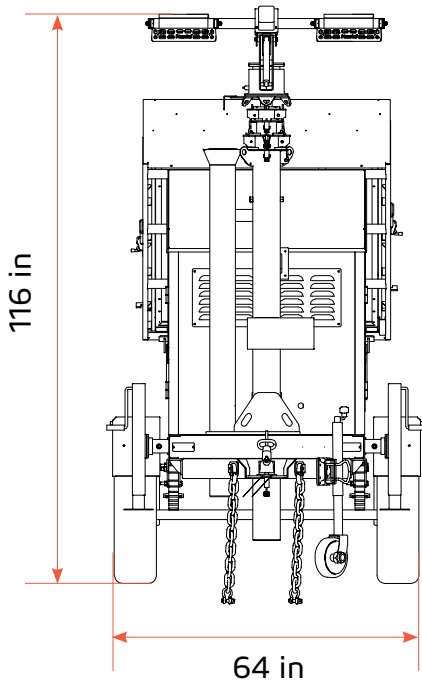

All measurements are approximate and for estimation purposes only.

SUPER EMPOWER reserves the right to update all product data sheets at any time. Consult SUPER EMPOWER marketing specialists for publication updates at hello@super-empower.com

"WE EMPOWER WATT MATTERS"

OUR BRANDS



hello@super-empower.com

(510)891-1056

super-empower.com



Access our website by scanning our QR code

Copyright©2018–2025 SOLTECH LLC, All Rights Reserved.